

AUTOMATE™

Core Tilt Motor

Precisely control the openness of Venetians or simply recall a favorite position with the ARC enabled Tilt motor.



SIMPLIFIED RETROFIT

Easily install the motor into existing Venetians without the need to cut componentry.



PRECISE TILT CONTROL

Incrementally tilt Venetians to precisely dim or brighten any room with natural light.



FAVORITE POSITION

Regularly used positions can be set and activated at the quick touch of a button.

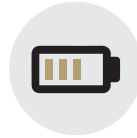

LI-ION BATTERY PACK INCLUDED

No need to use disposable batteries. Power the motor with the Automate rechargeable battery pack.



WAND CONTROL COMPATIBLE

Conveniently control the angle of venetian shades with either a remote or with a contemporary wand.



SOLAR PANEL COMPATIBLE

Using the 5V micro-USB adapter, keep the motor powered with the natural energy of the sun.

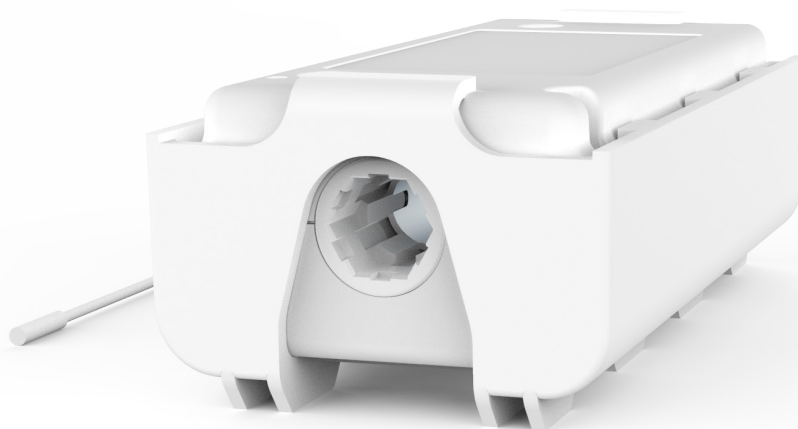

7
YEAR
WARRANTY



ARC™ (Automate Radio Communication) is Rollease Acmeda's proprietary technology utilizing 433MHz radio communication with bi-directional feedback that brings Automate motorized shading systems together.

A DIVISION OF
**ROLLEASE
ACMEDA**

PRODUCT SPECIFICATIONS

Part #: MT01-4001-069002 Core Tilt Motor Kit

Voltage	8.4V DC	Limit Switch Type	Electric
Torque	0.6Nm	Current	0.54 A
Max Run Time	6min	Battery Capacity/Type	2.2Ah (Li-ion)
Speed	10 RPM	Temp Working Range	14°F to 140°F (-10°C to 60°C)
Radio Frequency	433.92 MHz	Insulation Class	A
RF Modulation	FSK	Sound Level	~50 dB
IP Rating	IP20	Power	5 W

COMPATIBLE SYSTEMS

- Low Profile Headrail (1.5" x 2.25")

APPLICATIONS

- Venetians Blinds
- Wood Blinds

KIT CONTENTS

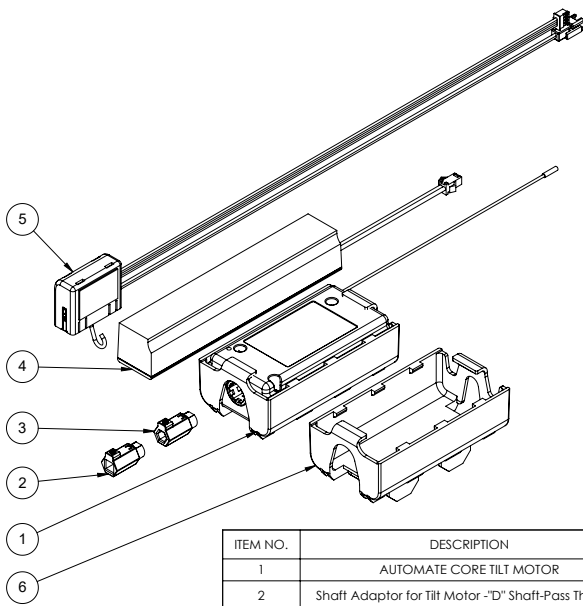

ITEM NO.	DESCRIPTION
1	AUTOMATE CORE TILT MOTOR
2	Shaft Adaptor for Tilt Motor "D" Shaft-Pass Through
3	5mm Hex Shaft Adapter
4	Rechargeable 8.4v Battery Pack
5	Hook Controller
6	Optional High Profile Cradle

DIMENSIONS

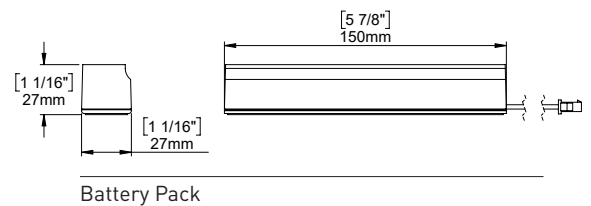
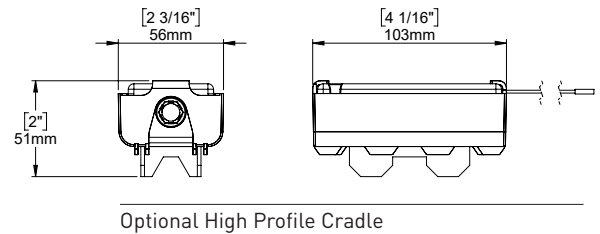
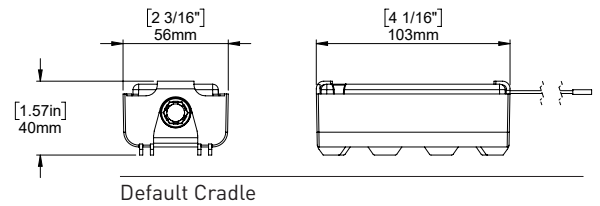

COMPATIBLE PRODUCTS (refer to catalog for full item listings)

Controllers

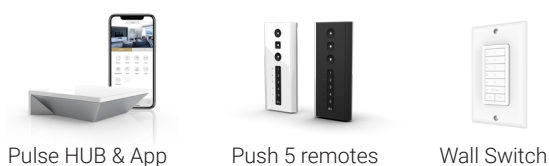

Charging Options

