

5V Wand Motor

Motor programming instructions



Electronic Limit



Selectable Speed



Battery Powered



Favorite Position



USB Charge

USE THIS DOCUMENT WITH THE FOLLOWING MOTORS:

PART NUMBER	DESCRIPTION
MT01-1325-069023-CT	5V ZERO LI-ION 1.1NM WAND CT20 Ø25/5V/28RPM S45
MT01-1325-069024-CT	5V ZERO LI-ION 1.1NM WAND CT20 Ø25/5V/28RPM SKY

AUTOMATE™ | Wand Motor & Wand Control offers a wire-free, rechargeable, easy to program and use solution to suit a large range of applications.

The favorite position feature allows a pre-set position to be recalled for precise alignment at a desired mid window position.

FEATURES:

- Lithium-ion battery powered
- Electronic Limits
- Selectable Speed
- Favorite Position
- USB Charge
- Battery Check Function
- Child Safe Wand Control - [Sold separately]

SAFETY INSTRUCTIONS

WARNING: Important safety instructions to be read before installation.

Incorrect installation can lead to serious injury and will void manufacturer's liability and warranty.

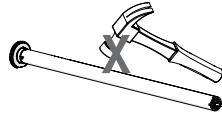
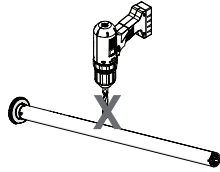

CAUTION

- Do not expose motor to moisture or extreme temperatures.
- Do not allow children to play with this device.
- Modification of motor in any shape or form will void warranty.
- Use or motor for other than intended use as outlined in this manual will void warranty.
- For use within tubular blinds.
- Ensure correct crown and drive adapters are used for the intended system.
- Keep antenna straight and clear from metal objects
- Do not cut the antenna.
- Use only Rollease Acmeda hardware.
- Ensure torque and operating time is compatible with system weight.
- Do not expose or immerse motor in water or install in humid or damp environments.
- Motor only to be installed horizontally.
- Do not drill into motor body.
- The routing of cable through walls shall be protected by isolating bushes or grommets.
- Ensure power cable and antenna is clear and protected from moving parts.
- Do not operate if cable or power connector is damaged.

Important safety instructions to be read prior to operation.

- It is important for the safety of persons to follow the enclosed instructions. Save these instructions for future reference.
- Persons (including children) with reduced mental capacity, or lack of experience and knowledge should not be allowed to use this product.
- Keep remote controls away from children.
- Frequently inspect for improper operation. Do not use if repair or adjustment is necessary.
- Keep motor away from acid and alkali.
- Do not force the motor drive.
- Keep clear when in operation.



Li-ion

Do not dispose of in general waste.

Please recycle batteries and damaged electrical products appropriately.



CONTENTS

1	ASSEMBLY	4
2	OPERATION NOTE	5
3	BUTTON DESCRIPTION	5
4	INITIAL SETTINGS	6
4.1	Factory Settings	6
4.2	Change Motor Direction of Rotation	6
4.3	Set Limits	7
5	ADJUSTING LIMITS	8
5.1	Adjust Upper Limit	8
5.2	Adjust Lower Limit	9
6	FAVORITE POSITIONING	10
6.1	Setting a Favorite Position	10
6.2	Send Shade to Favorite Position	10
7	STEPPING MODE	11
7.1	Enter Stepping Mode	11
7.2	Exit Stepping Mode	11
8	ADJUSTING SPEED	12
8.1	Increase Motor Speed	12
8.2	Decrease Motor Speed	12
9	BATTERY CHECK FUNCTION	13
9.1	Send Shade to battery charge level	13
10	RESTORE FACTORY SETTINGS	13
11	MOTOR LED - COLOR STATUS	14
12	TROUBLE SHOOTING	14

1 ASSEMBLY

Please refer to Rollease Acmeda System Assembly Manual for full assembly instructions relevant to the hardware system being used.

Step 1. Cut roller tube to required length.

Step 2. Ensure roller tube is clean and free from burrs.

Step 3. If is required, fit the crown, drive and bracket adapters.

Tube must be close fitting with chosen crown and drive adapters. Refer to Rollease Acmeda System Assembly Manual for recommended crown, drive, and bracket adapter kits.

Step 4. Slide Motor into tube.

Insert by aligning keyway in crown and drive wheel to the tube.

Step 5. Installation:

Assemble motor and tube assembly to the bracket.

Step 6. Attach the Wand to the Motor:

Ensure power connector is attached to motor head.

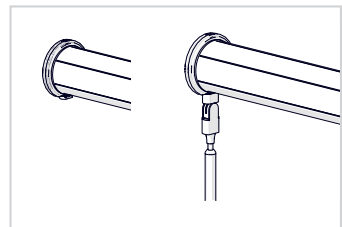
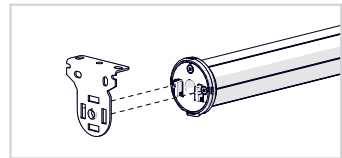
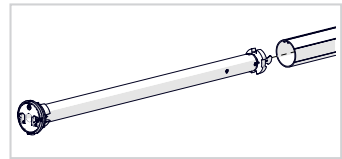
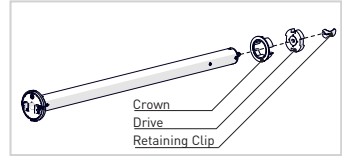
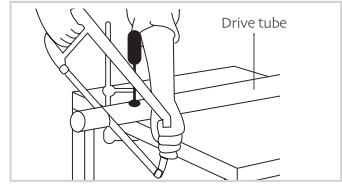

2 OPERATION NOTE

This motor has a 8.4V built-in Li-ion battery pack with integrated charge management.

- Before first use ensure that the motor is fully charged, indicated by a solid blue LED on the motor head.
- If battery is getting low, the LED on the motor will flash 8 times when the motor starts moving.
- Ensure limit positions are set before use to avoid damaging the motor or shade.
- To prevent damage to the motor or shade, ensure no objects are blocking the free movement of the shade.
- On first use and after factory resetting, the motor is in a 'sleep mode' to conserve battery life. Please press the P1 button on the motor head for 2 seconds, causing the motor to jog. The motor is now out of 'sleep mode' and able to detect a wand control.
- To indicate that a wand control has been successfully connected, the motor will jog.

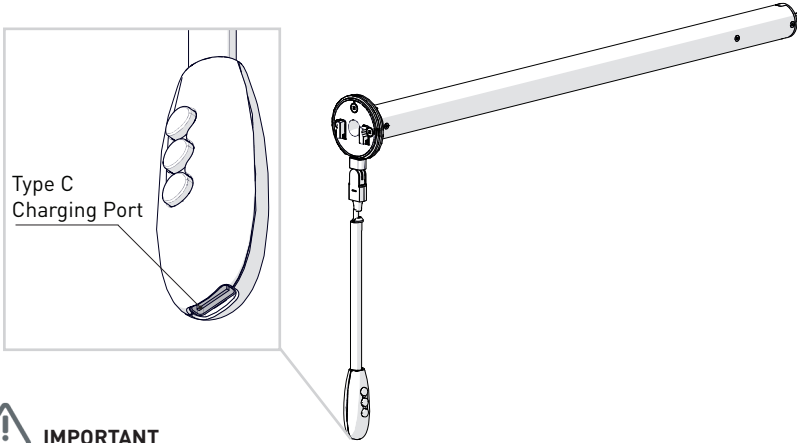

IMPORTANT

Ensure that the wand connector cable are kept clear of fabric.

3 BUTTON DESCRIPTION

MANUAL KEY:

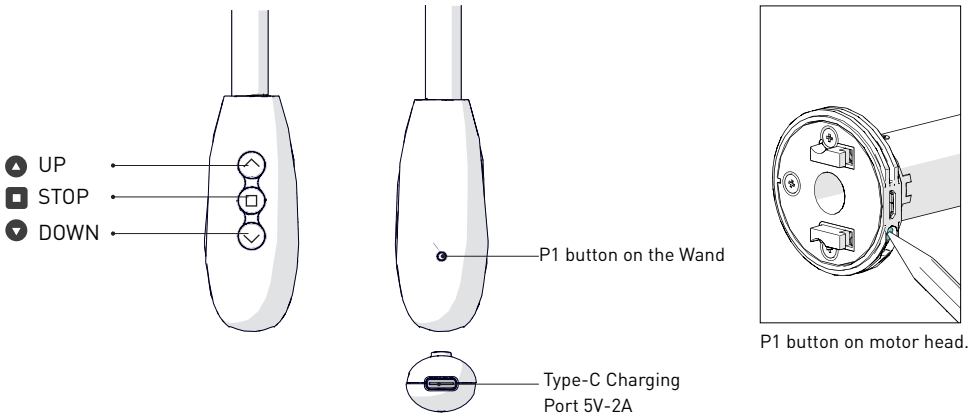

4 INITIAL SETTINGS

4.1 Factory Settings

To check travel direction of shade, press **UP** or **DOWN** on controller. If no response from the motor, press P1 (on motor head or wand) for 2 seconds to wake the motor from sleep mode.

Press **UP**
button



OR

Press **DOWN**
button



OR

Press **STOP**
button to stop motor



QUICK PRESS = Step



LONG PRESS = Continuous Travel



IMPORTANT

Damage to shade may occur when operating motor prior to setting limits. Attention should be given.

4.2 Change Motor Direction of Rotation

OPTION 1: If the shade direction needs to be reversed: press and hold the **UP & DOWN** arrow together for 2 sec until the motor Jogs.

Press & Hold
UP and **DOWN** Button



Motor Response

Approx. **JOG X1**

OPTION 2 (Only if the limits are all set): To reverse shade direction, press the P1 Button for 10 seconds.

Hold **P1** button



Motor Response

Approx. **JOG X3**

4.3 Set Limits

Move the shade into the desired highest location.

Hold **UP** button to start
Continous Travel



Press **STOP** button when shade is
at the desired position



Hold **UP &
STOP** button



Motor Response
Motor Stops

Motor Response

Approx.    JOG X2

Move the shade into the desired lowest location.

Hold **DOWN** button to
start Continous Travel



Press **STOP** button when shade is
at the desired position



Hold **DOWN
& STOP** button



Motor Response
Motor Stops

Motor Response

Approx.    JOG X2

IMPORTANT

The reversal of button directions option is unavailable while setting the Limits.

The motor will automatically go to Continuous Travel once the Limits are set.

5 ADJUSTING LIMITS

5.1 Adjust Upper Limit

Hold **UP** & **STOP** for 6 seconds to enter Adjustment Mode.

Hold **UP** &
STOP button



Motor Response



Move the shade into the desired highest location.

Press **UP** or **DOWN**
buttons to move shade

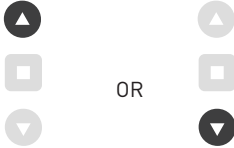

Hold **STOP** & **UP** button



Motor Response



IMPORTANT

The Upper Limit can **NOT** be changed if it is currently sitting at the maximum height possible.
Lower shade before beginning to change the upper Limit.



IMPORTANT

After entering the Limit Adjustment Mode, any Favorite Positions that have been saved are deleted and need to be re-programmed.
If 4 minutes pass with no button press, the motor will exit the Limit Adjustment Mode and no new positions are set.

5.2 Adjust Lower Limit

Hold **DOWN** & **STOP** for 6 seconds to enter Adjustment Mode.

Hold **DOWN** &
STOP button



Motor Response



Move the shade into the desired lowest location

Press **UP** or **DOWN**
buttons to move shade

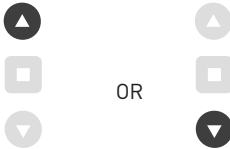

Hold **STOP** & **DOWN** button



Motor Response



IMPORTANT

The Lower Limit can NOT be changed if it is currently sitting at the lowest height possible. Raise shade before beginning to change the upper Limit.



IMPORTANT

After entering the limit adjustment mode, any favorite positions that have been saved are deleted and need to be re-programmed.

If 4 minutes pass with no button press, the motor will exit the limit adjustment mode and no new positions are set.

6 FAVORITE POSITIONING

6.1 Setting a Favorite Position

Move the shade into the desired position.

Press **UP** or **DOWN** buttons to move shade

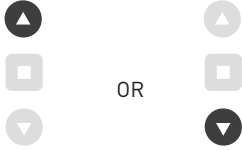

Press **STOP** button when shade is at the desired position.

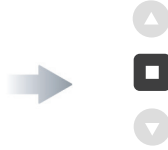

Hold **STOP** button



IMPORTANT

Setting of Favorite position must happen within 16 seconds after first pressing the **STOP** button



IMPORTANT

The Favorite Position can **NOT** be set at the Upper or Lower Limit.

Adjustment of the Upper or Lower Limit will delete the Favorite Position from the Motor and needs to be reset.

Motor Response when Favorite Position is set



Motor Response when Favorite Position is removed



6.2 Send Shade to Favorite Position

Press **STOP** button when the shade is already stopped.



7 STEPPING MODE

7.1 Enter Stepping Mode

Press **P1** button



Motor Response



Press **STOP** button



Motor Response



Press **STOP** button



Motor Response



IMPORTANT

In stepping mode, Press **UP** or **DOWN** for 2 seconds to step or Long Press for continuous Travel.



QUICK PRESS = Step



LONG PRESS = Continuous Travel

7.2 Exit Stepping Mode

Press **P1** button



Motor Response



Press **STOP** button



Motor Response



Press **STOP** button



Motor Response



8 ADJUSTING SPEED

8.1 Increase Motor Speed

Default motor mode is the slowest speed.

Press **P1** button



Press **STOP** button



Press **UP** button



8.2 Decrease Motor Speed

Press **P1** button



Press **STOP** button



Press **DOWN** button



9 BATTERY CHECK FUNCTION

9.1 Send Shade to battery charge level

Shade must be at Upper Limit.

Hold UP



Motor Response

Approx. 

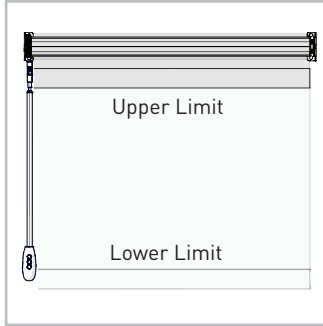

Shade must be at Upper Limit
Hold UP for Approx. 5s

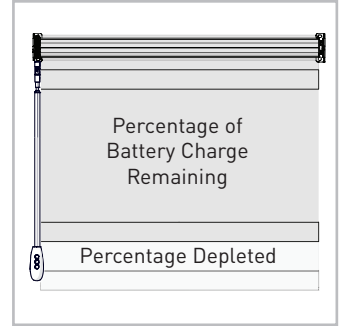

Shade moves to percentage of
battery charge remaining

10 RESTORE FACTORY SETTINGS

Hold P1 for 16 seconds to restore Factory Settings.

Hold **P1** button



Motor Response

Approx.   JOG X4

11 MOTOR LED - COLOR STATUS

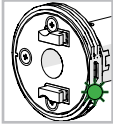
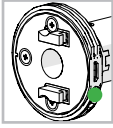
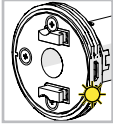
LED Color	LED Status	Description
	Green LED blinking	Green LED will blink when the motor is charging.
	Green LED solid	Green LED is solid when the motor is fully charged.
	Yellow LED blinking	Yellow LED will blink when pressing the motor head button or P button on back of the remote jog indication.

12 TROUBLE SHOOTING

automateshades.com

Problem	Cause	Remedy
The wand LED flashes when the motor is working.	The battery voltage is low.	Recharge battery with compatible AC adapter.
The motor is not responding.	Battery in motor is depleted.	Recharge battery with compatible AC adapter.
	Power Failure.	Check power connector is attached correctly to motor head.
	Incorrect Wiring.	Check power connector is attached correctly to motor head.
	Motor in Sleep Mode.	Press and Hold the P1 Button for 2 seconds (On the motor head or on the Wand)

NOTES

A series of horizontal dotted lines for taking notes.

ROLLEASE ACMEDA | USA
Level 7 / 750 East Main Street
Stamford, CT 06902, USA
T +1 800 552 5100 | F +1 203 964 0513

ROLLEASE ACMEDA | AUSTRALIA
110 Northcorp Boulevard,
Broadmeadows VIC 3047, AUS
T +61 3 9355 0100 | F +61 3 9355 0110

ROLLEASE ACMEDA | EUROPE
Via Conca Del Naviglio 18,
Milan (Lombardia) Italy
T +39 02 8982 7317 | F +39 02 8982 7317