

DCFT MOTOR



433 Mhz
Bi-Directional



Electronic
Limit



Favorite
Position



Fabric
Tension



Ultra
Lock



Battery
Check



Impact
Detection

USE THIS DOCUMENT WITH THE FOLLOWING MOTORS:

PART NUMBER	DESCRIPTION
MT01-1245-069001	AUTOMATE DCFT 15 ARC Motor [Ø45/15Nm/10rpm]

AUTOMATE | DCFT tubular motors combine the simple, intuitive features of ARC "Automate Radio Communication" with Fabric Tension capability and DC power. Three alternate modes of operation include:

- E-type for standard use
- MANUAL FT Mode for use with conventional locking devices with fabric tensioning
- AUTO FT Mode for use with Rollease Acmeda's proprietary ULTRA LOCK providing automatic fabric tensioning

Functional options in each operating mode include: FAVORITE POSITION & BATTERY CHECK.

- An intermediate setting allows for a customized FAVORITE POSITION to be preset.
- The BATTERY CHECK feature lowers the shade to the level of charge remaining in the battery pack when triggered.
- IMPACT DETECTION senses an obstacle in the blinds path during downward movement and redirects the shade to protect the motor, hardware and fabric, ensuring product longevity.

SAFETY INSTRUCTIONS

WARNING: Important safety instructions to be read before installation.

Incorrect installation can lead to serious injury and will void manufacturer's liability and warranty.

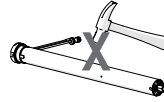
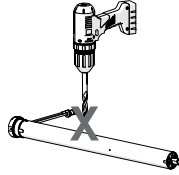

WARNING: Important safety instructions to be read before installation and use.

Incorrect installation or use can lead to serious injury and will void manufacturer's liability and warranty.

It is important for the safety of persons to follow the enclosed instructions. Save these instructions for future reference.

- Do not expose to water, moisture, humid and damp environments or extreme temperatures.
- Persons (including children) with reduced physical, sensory or mental capabilities, or lack of experience and knowledge should not be allowed to use this product.
- Use or modification outside the scope of this instruction manual will void warranty.
- Installation and programming to be performed by a suitably qualified installer.
- Follow installation instructions.
- For use with motorized shading devices.
- Keep away from children.
- Frequently inspect for improper operation. Do not use if repair or adjustment is necessary.
- Keep clear when in operation.

COMPLIANCE STATEMENT

This device complies with Part 15 of the FCC Rules. Operation is subject to the following two conditions:

- (1) This device may not cause harmful interference, and
- (2) this device must accept any interference received, including interference that may cause undesired operation.

Le présent appareil est conforme aux CNR d'Industrie Canada applicables aux appareils radio exempts de licence. L'exploitation est autorisée aux deux conditions suivantes:

(1) l'appareil ne doit pas produire de brouillage, et

(2) l'utilisateur de l'appareil doit accepter tout brouillage radioélectrique subi, même si le brouillage est susceptible d'en compromettre le fonctionnement.

Caution: Changes or modifications not expressly approved by the party responsible for compliance could void the user's authority to operate the equipment.

NOTE: This equipment has been tested and found to comply with the limits for a Class B digital device, pursuant to part 15 of the FCC Rules. These limits are designed to provide reasonable protection against harmful interference in a residential installation.

This equipment generates, uses and can radiate radio frequency energy and, if not installed and used in accordance with the instructions, may cause harmful interference to radio communications. However, there is no guarantee that interference will not occur in a particular installation.

If this equipment does cause harmful interference to radio or television reception, which can be determined by turning the equipment off and on, the user is encouraged to try to correct the interference by one or more of the following measures:

- Reorient or relocate the receiving antenna.
- Increase the separation between the equipment and receiver.
- Connect the equipment into an outlet on a circuit different from that to which the receiver is connected.
- Consult the dealer or an experienced radio/TV technician for help.



Do not dispose of in general waste.
Please recycle batteries and damaged
electrical products appropriately.



CONTENTS

1	ASSEMBLY + INSTALLATION OF MOTOR	4		
2	BATTERY PACK MOUNTING OPTIONS	4		
2.1	Cassette mounting holes x2	4		
3	WIRING ROUTING	5		
3.1	Cassette Front Cover	5		
3.2	Cassette End Plate	5		
4	SELECTABLE MODE	6		
4.1	Impact Detection	6		
5	P1 BUTTON FUNCTIONS	7		
5.1	Motor state test	7		
5.2	Motor configuration options	7		
6	INITIAL SET UP	8		
6.1	Pair motor with controller	8		
6.2	Check motor direction	8		
6.3	Set Limits	9		
7	ADJUSTING LIMITS	10		
7.1	Adjust upper limit	10		
7.2	Adjust lower limit	10		
8	FAVORITE POSITIONING	11		
8.1	Set a favorite position	11		
8.2	Send shade to favorite position	11		
8.3	Delete favorite position	11		
9	FABRIC TENSION SETTING	12		
9.1	Activate/Deactivate FT Mode	12		
9.2	Switching Auto & Manual Lock Modes	12		
9.3	Auto Mode Operation	13		
9.4	Manual Mode Operation	13		
9.5	Activate/Deactivate Impact Detection Mode	14		
10	CONTROLLERS AND CHANNELS	15		
10.1	Using motor P1 Button to add a new controller or channel	15		
10.2	Using a pre-existing controller to add or delete a controller or channel	15		
11	SLEEP MODE	16		
12	BATTERY CHECK FUNCTION	16		
12.1	Send Shade to battery charge level	16		
13	WIND AND SUN SENSOR	17		
13.1	Activate/Deactivate sensor functionality	17		
13.2	Pairing Wind and Sun sensor to Motor	17		
14	TROUBLE SHOOTING	18		
15	NOTES	19		

1 ASSEMBLY + INSTALLATION OF MOTOR

Please refer to Rollease Acmeda System Assembly Manual for full assembly instructions relevant to the hardware system being used.

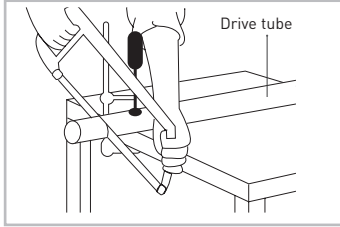

Cut roller tube to required length & de-burr.

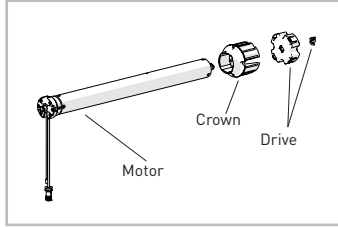

Fit required crown, drive and bracket adapters.

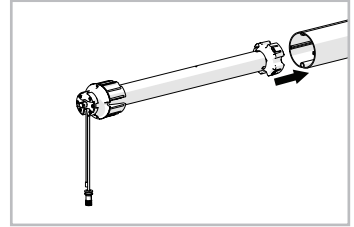

Assemble tube with motor.

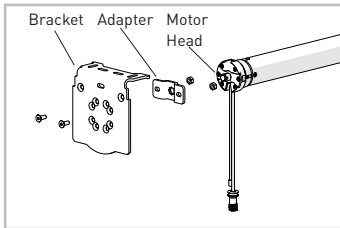

Mount motorized tube onto brackets.

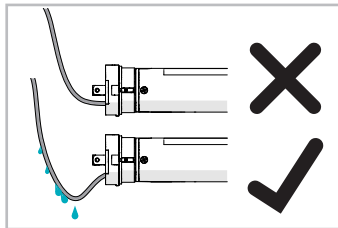

Note: Ensure Motor is rotated so that cable is at the bottom of the motor as illustrated.

2 BATTERY PACK MOUNTING OPTIONS

2.1 Cassette mounting holes x2

NOTE: If using a compatible external battery, such as MT03-0305-050011, please use the following steps.

Battery must only be charged by Rollease Acmeda battery charger MT03-0301-050017.

Battery charger LED status: RED = Charging | GREEN = Idle

NOTE:

Battery pack will only charge between 0-45°C [32-113°F].

Battery pack must be installed out of direct sunlight.

Recommended to install the battery in a horizontal orientation to minimize the risk of water ingress. Ensure the battery is positioned away from direct contact with water or exposure to adverse weather conditions during installation.

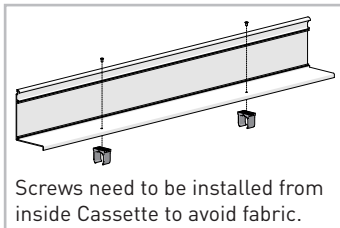

Screws need to be installed from inside Cassette to avoid fabric.

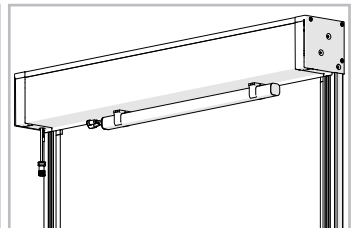
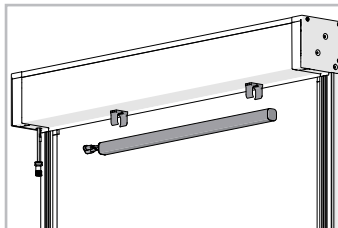

Ø4mm [3/16"] BATTERY PACK MOUNTING HOLES x2 & 465mm [18-5/16"] optimal bracket spacing

3 WIRING ROUTING

3.1 Cassette Front Cover

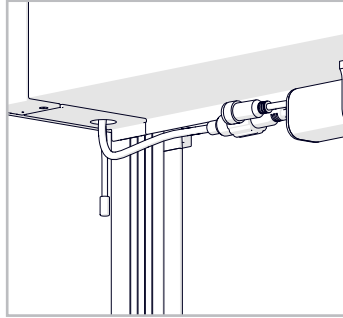
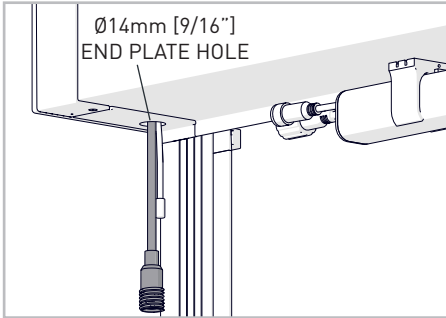

3.2 Cassette End Plate

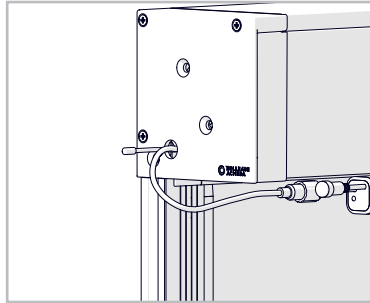
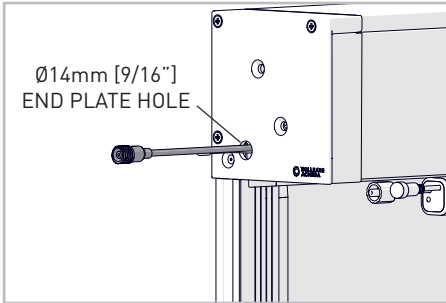

4 SELECTABLE MODE

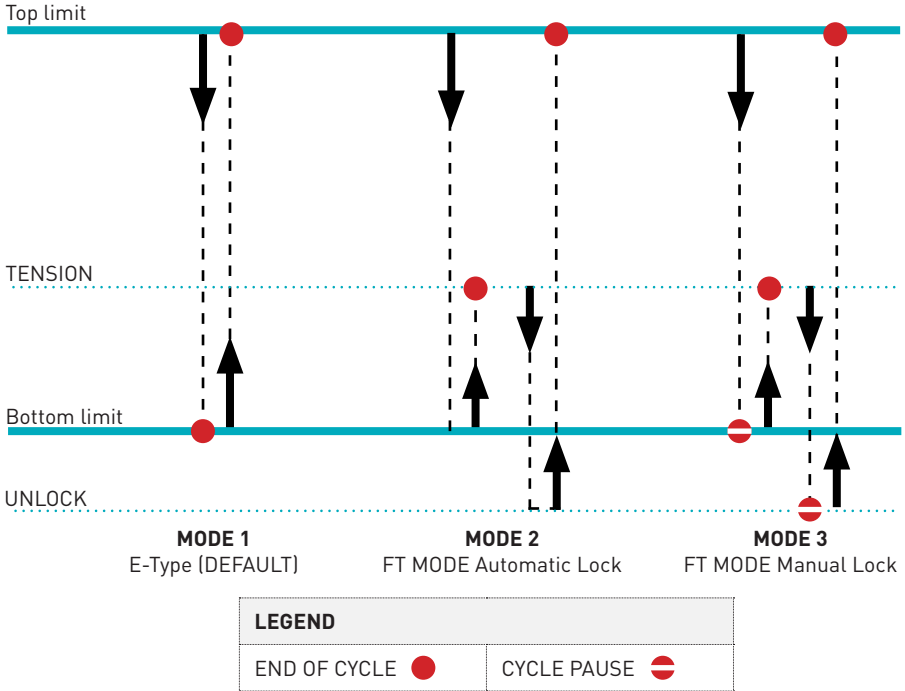

4.1 Impact Detection

Impact detection is deactivated by default. Impact detection may be activated in all 3 modes. If an obstacle is detected twice in the shade path during downwards movement, the motor lifts the shade up ~ 7.87in. [20cm].

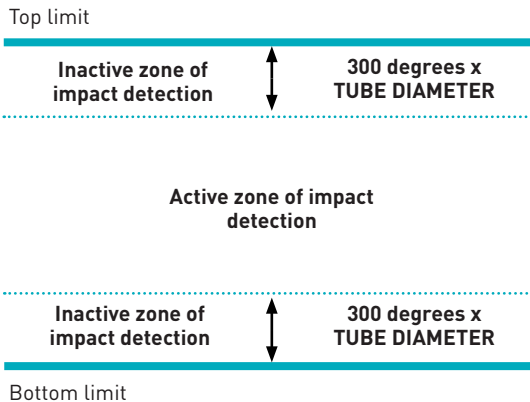

NOTE

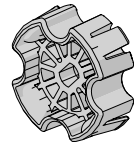

This DCFT motor features internal impact detection technology that requires a 1-piece drive be used, such as MT03-0106-050006.

A 2 part drive adaptor, as used on the AC FT motor, is not compatible with the drive shaft.

5 P1 BUTTON FUNCTIONS

5.1 Motor state test

This table describes the function of a short **P1** Button press/release (<2 seconds) depending on current motor configuration.

P1 Press	Condition	Function Achieved	Visual Feedback	Audible Feedback	Function Described
Short Press	If limit is NOT set	None	No Action	None	No Action
	If limits are set	Operational control of motor, run to limit. Stop if running	Motor Runs	None	Operational control of motor after pairing and limit setting is completed first time
	If motor is in "Sleep Mode" & limits are set	Wake and control	Motor wakes and runs in a direction	None	Motor is restored from Sleep Mode and RF control is active

5.2 Motor configuration options

The **P1** Button is utilized to administer motor configurations as described below.

Hold **P1** button on motor head.

Activate Pairing Mode



Sleep Mode



Reverse Direction



Reset To Factory Settings

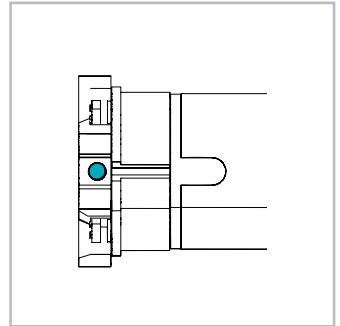

P1 button on motor head.

6 INITIAL SET UP

6.1 Pair motor with controller

Select channel on controller.



Press the **P1** button until the motor responds then release.

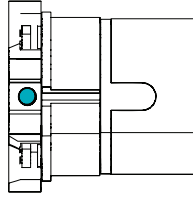

Hold **STOP** on controller.



IMPORTANT

Consult user manual for your controller for information on selecting channel.

Motor Response



Motor Response



Motor is now in step mode and ready for setting limits

6.2 Check motor direction

To check travel direction of shade, press **UP** or **DOWN** on controller.

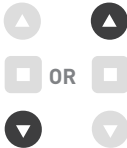

To reverse shade direction, hold both **UP** and **DOWN**.

Until the motor responds.



Quick Press = Step

Long Press = Continuous Travel

Motor Response



IMPORTANT

Damage to shade may occur when operating motor prior to setting limits. Attention should be given.

IMPORTANT

Reversing motor direction using this method is only possible during initial set-up

6.3 Set Limits

IMPORTANT

Cycle shade up and down prior to setting limits to settle fabric

Move shade to the desired highest or lowest position by pressing the **UP** or **DOWN** buttons on controller.



To save upper limit, hold **UP** and **STOP**.



Motor Response



Move shade to the desired highest or lowest position by pressing the **UP** or **DOWN** buttons on controller.



To save lower limit, hold **DOWN** and **STOP**.



Motor Response



IMPORTANT

After setting limits, motor will automatically exit from initial set-up mode.

7 ADJUSTING LIMITS

7.1 Adjust upper limit

Hold **UP** and **STOP** on controller.



Move shade to the desired highest position by pressing the **UP** or **DOWN** button.

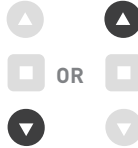

To save upper limit, hold **UP** and **STOP**.



Motor Response



Motor Response



7.2 Adjust lower limit

Hold **DOWN** and **STOP** on controller.



Move shade to the desired lowest position by pressing the **UP** or **DOWN** button.

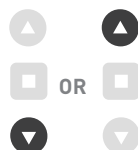

To save lower limit, hold **DOWN** and **STOP**.



Motor Response



Motor Response



IMPORTANT (ULTRA-LOCK V2 ONLY)

When using the Ultra-lock V2, the bottom limit must be set within the 'locking zone'. Jog the weight bar down until you hear both locking pins click into each housing.

8 FAVORITE POSITIONING

8.1 Set a favorite position

Move shade to the desired position by pressing the **UP** or **DOWN** button on the controller.

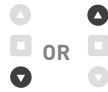

Press **P2** on controller.



Press **STOP** on controller.



Press **STOP** on controller.



Motor Response



Motor Response



Motor Response



8.2 Send shade to favorite position



Approx. 2secs

8.3 Delete favorite position

Press **P2** on controller.



Press **STOP** on controller.



Press **STOP** on controller.



Motor Response



Motor Response



Motor Response



9 FABRIC TENSION SETTING

9.1 Activate/Deactivate FT Mode

Note: When activating FT Mode for the first time, AUTOMATIC Lock Mode is selected. FT Mode is deactivated by default.

Press **P2** on controller.



Press **UP** on controller.



Press **UP** on controller.



FT MODE:

Motor Response



NO FT MODE:

Motor Response



9.2 Switching Auto & Manual Lock Modes

Note: Motor must be in FT mode before switching between lock modes.

Press **P2** on controller.



Press **STOP** on controller.



Press **DOWN** on controller.



AUTO MODE:

Motor Response



MANUAL MODE:

Motor Response



9.3 Auto Mode Operation

LOCK

Press **DOWN** on controller.

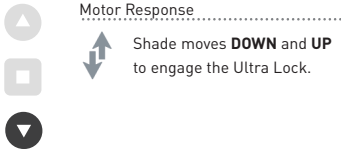

UNLOCK

Press **UP** on controller.

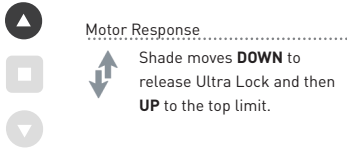

9.4 Manual Mode Operation

LOCK

Press **DOWN** on controller.

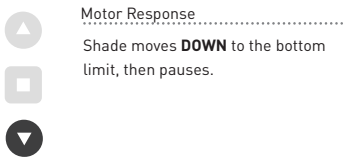

Press **UP** on controller.

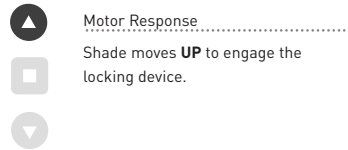

UNLOCK

Press **DOWN** on controller.

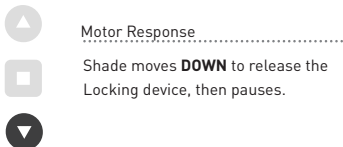

Press **UP** on controller.

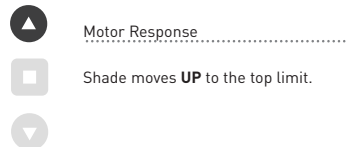

9.5 Activate/Deactivate Impact Detection Mode

The Impact Detection feature only works in the active zone during downward movement (see Section 4.2). All three modes have this impact detection feature deactivated by default (see Section 2.1). Repeat sequence to turn on or off as required.

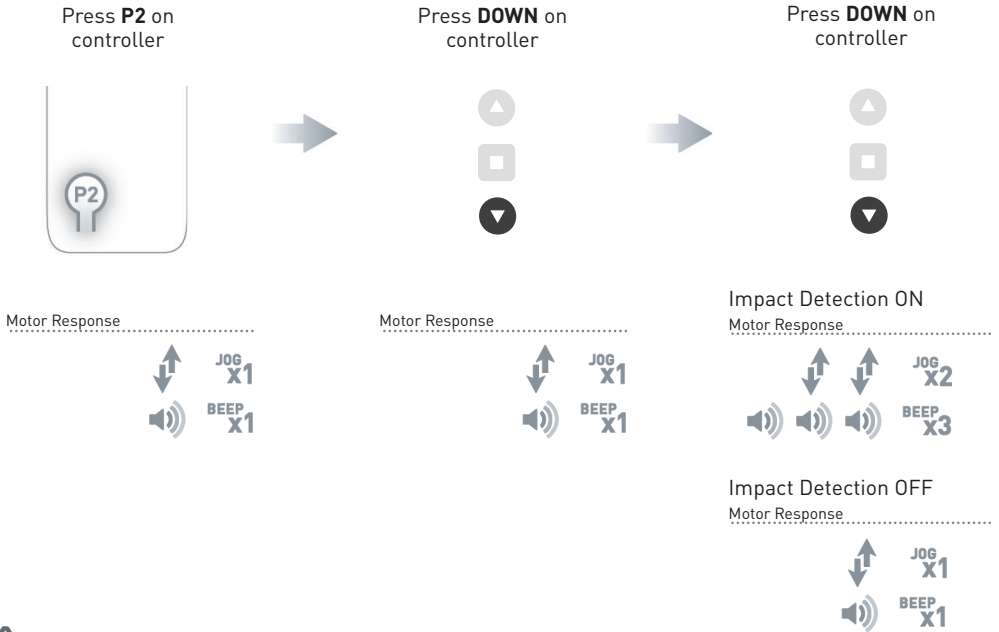

IMPORTANT

The top tube must be able to freely rotate ~ 5 degrees after installation.

10 CONTROLLERS AND CHANNELS

10.1 Using motor P1 Button to add a new controller or channel

A = Existing controller or channel (to keep)

B = Controller or channel to add or remove

Press **P1** on motor head.

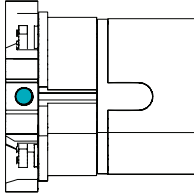

Hold **STOP** on a new controller to add it. Motor keeps original limits.



Motor Response.....



Motor Response.....



IMPORTANT Consult user manual for your controller or sensor

10.2 Using a pre-existing controller to add or delete a controller or channel

A = Existing controller or channel (to keep)

B = Controller or channel to add or remove

Press **P2** on controller **A**.



Press **P2** on controller **A**.

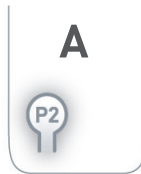

Press **P2** on the controller **B** to remove it.



Motor Response.....



Motor Response.....



Motor Response.....



IMPORTANT Consult user manual for your controller or sensor

11 SLEEP MODE

If multiple motors are grouped on a single channel, Sleep Mode may be used to put all but 1 motor to sleep, allowing programming of just the one motor that remains "Awake".

Enter Sleep Mode

Sleep mode is utilized to prevent a motor from incorrect configuration during other motor setup.

Hold **P1** button on the motor head

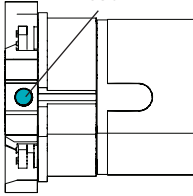

Motor Response

Approx. **RELEASE P1** **BEEP X2**

Exit Sleep Mode: Method 1

Exit sleep mode once the shade is ready.

Press and release **P1** button on the motor head

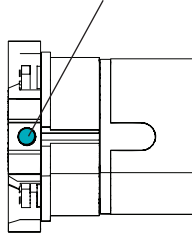

Motor Response

JOG X1

Exit Sleep Mode: Method 2

Remove power and then re-power the motor.

12 BATTERY CHECK FUNCTION

12.1 Send Shade to battery charge level

Shade must be at Upper Limit.

Hold **UP**



Motor Response

Approx.

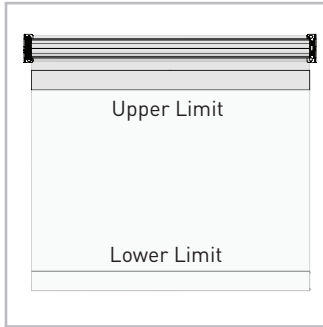

Shade must be at Upper Limit
Hold **UP** for Approx. 5s

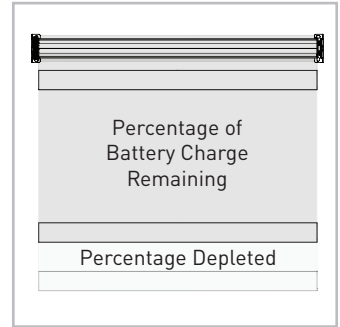

Shade moves to percentage of
battery charge remaining

13 WIND AND SUN SENSOR

Ensure the Wind and Sun sensor functionality on the motor is activated prior to pairing the Wind and Sun sensor.

13.1 Activate/Deactivate sensor functionality

Note: Functionality activated by default.

PRESS **P2** ON CONTROLLER



Motor Response



PRESS **UP** ON CONTROLLER



Motor Response



PRESS **STOP** ON CONTROLLER



Motor Response (Activated)



Motor Response (Deactivated)



13.2 Pairing Wind and Sun sensor to Motor

ON REMOTE

PRESS **P2** ON CONTROLLER



Motor Response



PRESS **P2** ON CONTROLLER



Motor Response



ON SENSOR

PRESS **P2** TO WAKE THE SENSOR



PRESS **P2** ON AN EXISTING CONTROLLER TO ADD OR REMOVE IT.



Motor Response



IMPORTANT: WIND SENSOR PRIORITIZE FUNCTION

Once the motor receives a command from the wind sensor, the motor will respond accordingly. At this point the motor will ignore any other remote or sensor commands for 8 minutes. This is needed to avoid contradicting multiple triggers. Keep this in mind when testing the motor with the remote after the wind sensor has been triggered. The wind sensor function is ON by default.

NOTE: Motor will jog to alert user if operated within 8 minutes.

Problem	Cause	Remedy
Motor is not responding	Connected Battery is depleted or Power Supply is not working	Recharge with a compatible charger
	Transmitter battery is discharged	Replace battery
	Battery is inserted incorrectly into transmitter	Check battery polarity
	Radio interference/shielding	Ensure transmitter is positioned away from metal objects and the aerial on motor or receiver is kept straight and away from metal
	Receiver distance is too far from transmitter	Move transmitter to a closer position
	Charging failure	Check power supply to motor is connected and active
	Power Failure	Check power supply to motor is connected and active.
Motor beeps x10 when in use	Battery voltage is low	Recharge with a compatible charger
Cannot program a single motor (multiple motors respond)	Multiple motors are paired to the same channel	Always reserve an individual channel for programming functions. Use Sleep Mode to program individual motors.

A large rectangular area enclosed by a dotted border, intended for handwritten notes.

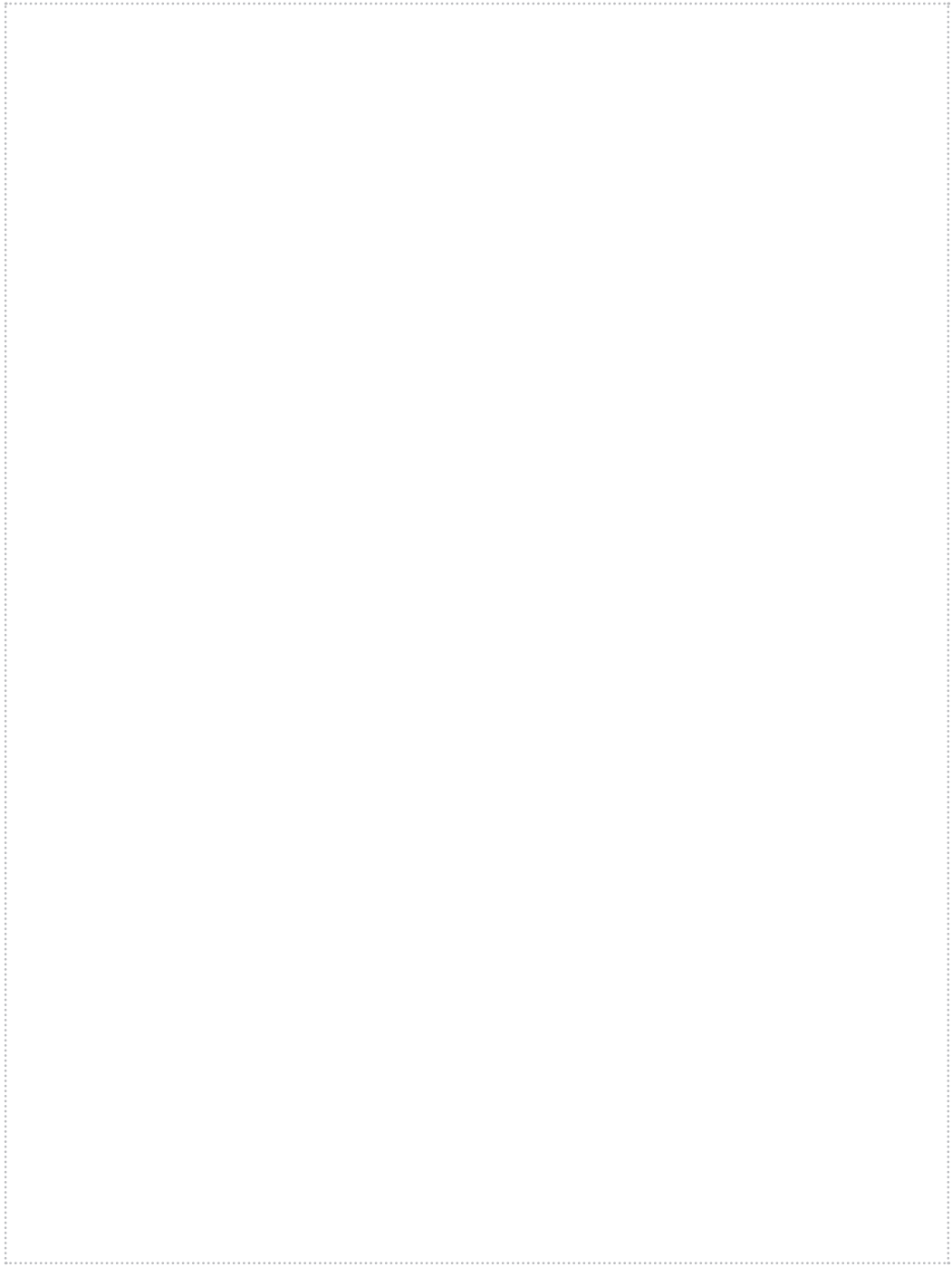

ROLLEASE ACMEDA | USA
Level 7 / 750 East Main Street
Stamford, CT 06902, USA
T +1 800 552 5100 | F +1 203 964 0513

ROLLEASE ACMEDA | AUSTRALIA
110 Northcorp Boulevard,
Broadmeadows VIC 3047, AUS
T +61 3 9355 0100 | F +61 3 9355 0110

ROLLEASE ACMEDA | EUROPE
Via Conca Del Naviglio 18,
Milan (Lombardia) Italy
T +39 02 8982 7317 | F +39 02 8982 7317