

AUTOMATE™

Paradigm Flush Wall Switch



433 MHz

AUTOMATE™ | Paradigm flush wall switches feature a contemporary design and a wirefree deployment, making them retrofit ready for any location. Paradigm 5 channel switches are perfect for individual shade, room and whole home control.

The Paradigm flush mount switch can be mounted on top of any surface. Its slim profile eliminates the need for any holes to be cut in walls.

FEATURES:

- Multi channel selectable
- Retrofit Ready
- Group Control
- Compatible with screwless decorator cover plates
- Optionally functions as handheld remote

SAFETY INSTRUCTIONS

WARNING: Important safety instructions to be read before installation and use.

Incorrect installation can lead to serious injury and will void manufacturer's liability and warranty.

WARNING: Important safety instructions to be read before installation and use.

Incorrect installation or use can lead to serious injury and will void manufacturer's liability and warranty. It is important for the safety of persons to follow the enclosed instructions. Save these instructions for future reference.

- Do not expose to water, moisture, humid and damp environments or extreme temperatures.
- Persons (including children) with reduced physical, sensory or mental capabilities, or lack of experience and knowledge should not be allowed to use this product.
- Use or modification outside the scope of this instruction manual will void warranty.
- Installation and programming to be performed by a suitably qualified installer.
- Follow installation instructions.
- For use with motorized shading devices.
- Keep away from children.
- Frequently inspect for improper operation. Do not use if repair or adjustment is necessary.
- Keep clear when shades are in operation.
- Replace battery with correctly specified type.



Warning: contains coin battery

Battery: CR2430 | 3VDC

WARNING: Important safety instructions to be read before installation and use.

This product contains a coin/button cell battery. If the coin/button cell battery is swallowed, it can cause severe internal burns in just 2 hours and can lead to death. Keep new and used batteries away from children. If the battery compartment does not close securely, stop using the product and keep away from children. If you think batteries might have been swallowed or placed inside any part of the body, seek immediate medical attention.

- Remove and immediately recycle or dispose of used batteries according to local regulations and keep away from children. Do NOT dispose of batteries in household trash or incinerate.
- Even used batteries may cause severe injury or death.
- Call a local poison control center for treatment information.
- Non-rechargeable batteries are not to be recharged.
- Do not force discharge, recharge, disassemble, heat above (manufacturer's specified temperature rating) or incinerate. Doing so may result in injury due to venting, leakage or explosion resulting in chemical burns.
- Ensure the batteries are installed correctly according to polarity (+ and -).
- Do not mix old and new batteries, different brands or types of batteries, such as alkaline, carbon-zinc, or rechargeable batteries.
- Remove and immediately recycle or dispose of batteries from equipment not used for an extended period of time according to local regulations.
- Always completely secure the battery compartment. If the battery compartment does not close securely, stop using the product, remove the batteries, and keep them away from children.

⚠ WARNING	
<ul style="list-style-type: none">• INGESTION HAZARD: This product contains a button cell or coin battery.• DEATH or serious injury can occur if ingested.• A swallowed button cell or coin battery can cause Internal Chemical Burns in as little as 2 hours.• KEEP new and used batteries OUT OF REACH of CHILDREN• Seek immediate medical attention if a battery is suspected to be swallowed or inserted inside any part of the body.	

COMPLIANCE STATEMENT

This device complies with Part 15 of the FCC Rules / Industry Canada licence-exempt RSS standard(s). Operation is subject to the following two conditions:

- (1) this device may not cause harmful interference, and
- (2) this device must accept any interference received, including interference that may cause undesired operation.

Le présent appareil est conforme aux CNR d'Industrie Canada applicables aux appareils radio exempts de licence. L'exploitation est autorisée aux deux conditions suivantes:

- (1) l'appareil ne doit pas produire de brouillage, et
- (2) l'utilisateur de l'appareil doit accepter tout brouillage radioélectrique subi, même si le brouillage est susceptible d'en compromettre le fonctionnement.

Changes or modifications not expressly approved by the party responsible for compliance could void the user's authority to operate the equipment.

This equipment has been tested and found to comply with the limits for a Class B digital device, pursuant to part 15 of the FCC Rules. These limits are designed to provide reasonable protection against harmful interference in a residential installation.

This equipment generates uses and can radiate radio frequency energy and, if not installed and used in accordance with the instructions, may cause harmful interference to radio communications. However, there is no guarantee that interference will not occur in a particular installation.

If this equipment does cause harmful interference to radio or television reception, which can be determined by turning the equipment off and on, the user is encouraged to try to correct the interference by one or more of the following measures:

- Reorient or relocate the receiving antenna.
- Increase the separation between the equipment and receiver.
- Connect the equipment into an outlet on a circuit different from that to which the receiver is connected.
- Consult the dealer or an experienced radio/TV technician for help.

To satisfy FCC / IC RF exposure requirements, a separation distance of 20 cm or more should be maintained between the antenna of this device and persons during device operation.

To ensure compliance, operations at closer than this distance is not recommended.

Les antennes installées doivent être situées de façon à ce que la population ne puisse y être exposée à une distance de moins de 20 cm. Installer les antennes de façon à ce que le personnel ne puisse approcher à 20 cm ou moins de la position centrale de l'antenne.

La FCC des états-unis stipule que cet appareil doit être en tout temps éloigné d'au moins 20 cm des personnes pendant son fonctionnement.



Do not dispose of in general waste.
Please recycle batteries and damaged electrical products appropriately.

FCC ID: 2AGGZMTRFWS5FLUSH
ID: 21769-MTRFWS5FLUS



CONTENTS

1	TECHNICAL DATA / PACK CONTENTS	5
2	INSTALLATION	6
2.1	Kit Components	6
2.2	Replace Battery	6
2.3	Magnetic Wall Clip	7
2.4	Fixed Wall Clip	7
3	FUNCTIONAL OVERVIEW	8
3.1	Buttons	8
3.2	Selecting a channel	8
4	PROGRAMMING	9
4.1	Using motor P1 button	9
4.2	Using pre-existing controller	10
5	INITIAL SET UP	11
5.1	Check motor direction	11
5.2	Set Limits	11
5.3	Locking the limit setting function	12
6	ADJUSTING LIMITS	13
6.1	Adjust upper limit	13
6.2	Adjust lower limit	13
7	FAVORITE POSITIONING	14
7.1	Set a favorite position	14
7.2	Send shade to favorite position	14
7.3	Delete favorite position	14
8	TROUBLE SHOOTING	15

1 TECHNICAL DATA / PACK CONTENTS

TECHNICAL SPECIFICATIONS	
Voltage:	3V (CR2430)
Frequency:	433.92 MHz
Transmitting Power:	Less than 10mW
Ambient Operating Temperature:	-10°C [°F] -50°C [122°F]
Transmission Distance:	20m - 100m [65' - 328'] (open space)

2 INSTALLATION

2.1 Kit Components

1. 1 x Cover
2. 1 x Switch Remote
3. 1 x Magnetic Wall Clip
4. 1 x Fixed Wall Clip
5. 2 x Pan Head Screw
6. 2 x Phillips Head Screw
7. 2 x Wall Plug
8. 3V - CR2430 Battery
9. Programming Manual
10. 1x Small Phillips Head Screw - Battery Cover
11. 1x PH0 Screw Driver

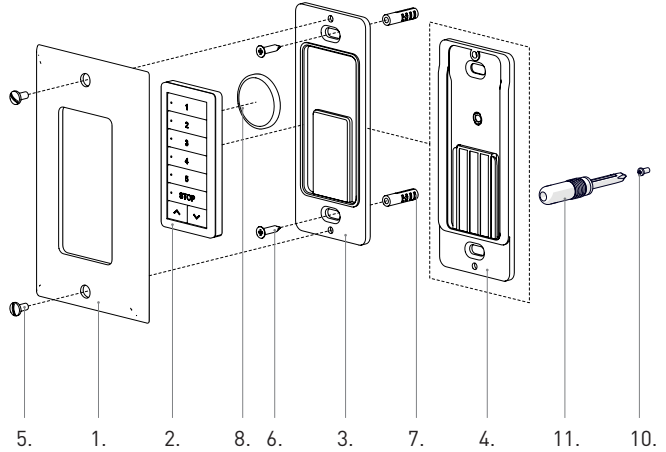

2.2 Replace Battery

Remove Screw

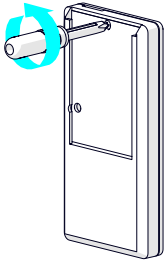

Open rear battery cover by gently separating switch covers with a screwdriver

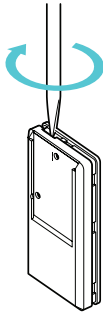

Install CR2430 battery with positive side facing up. Snap covers back together.

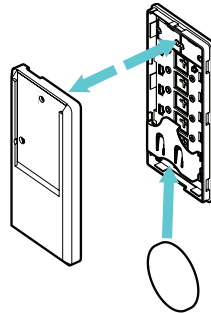

Snap covers back together.

Insert and fasten screw

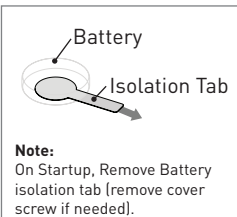
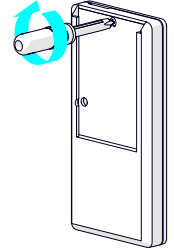

IMPORTANT

FOR CHILD SAFETY, SCREW MUST BE USED AT ALL TIMES TO SECURE BATTERY COVER IN PLACE.

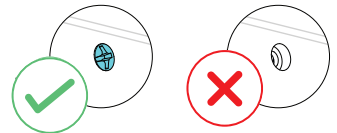

2.3 Magnetic Wall Clip

Use the Magnetic Wall Clip if you require the remote to be easily detachable.

Best Practice Tip:

Program the Switch to the motor prior to installation, then test radio performance in the location the switch will be installed in, to ensure best performance.

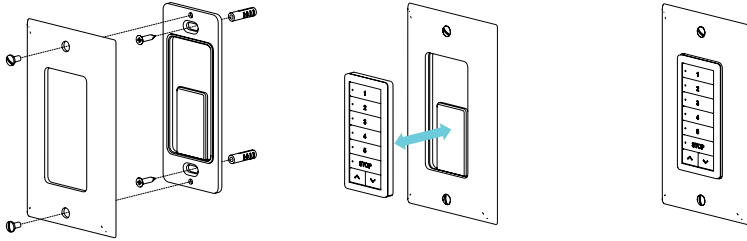

Use supplied fasteners and anchors as needed to attach the base and cover.

Switch is held in position magnetically and can be removed as desired.

Safely dispose of the unused Fixed Wall Clip.

2.4 Fixed Wall Clip

Use the Fixed Wall Clip if you require the remote to be non-removable.

Best Practice Tip:

Program the Switch to the motor prior to installation, then test radio performance in the location the switch will be installed in, to ensure best performance.

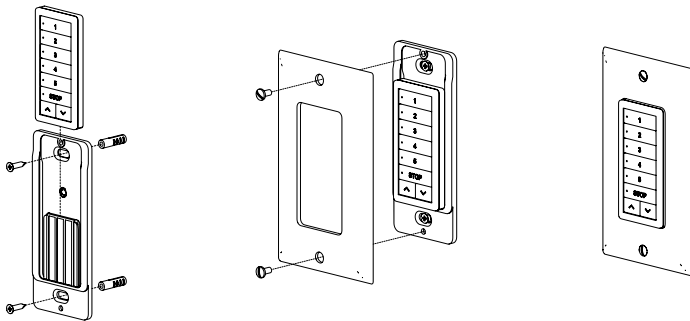

Slide the Switch onto the Wall Clip.

Use supplied fasteners and anchors as needed to attach the base and cover.

Switch is secured unless the Cover is removed.

Safely dispose of the unused Magnetic Wall Clip.

3 FUNCTIONAL OVERVIEW

3.1 Buttons

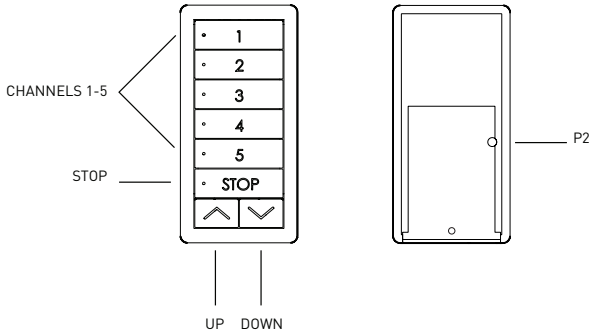

3.2 Selecting a channel

Press desired channel button(s)

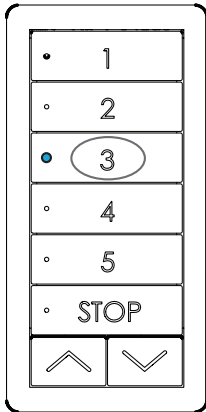

To deselect channel, press channel button until LED turns off

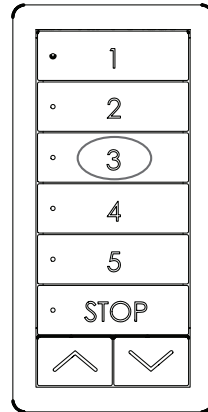

Motor Response

Blue LEDs will illuminate indicating channel selection.



IMPORTANT

Switch requires that at least one channel be selected at all times. First select an additional channel, then deselect channel you don't want to operate.

4 PROGRAMMING

4.1 Using motor P1 button



IMPORTANT

Multiple motors can be grouped onto shared channels for co-ordinated control. Limit settings and favorite positions cannot be adjusted when motors are grouped together.

- Confirm that motor limits and favorite position are already set for each individual motor.
- Ensure that each motor you want to group is also assigned to another channel by itself

Select a channel on switch.

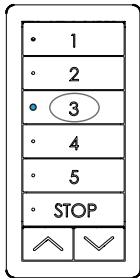

Hold **P1** button on motor head.

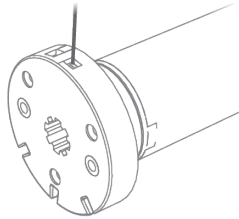

Hold **STOP** on switch.

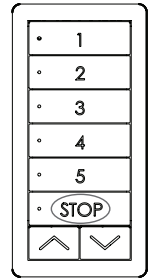

Motor Response

RELEASE P1



Motor Response



4.2 Using pre-existing controller

A = Existing switch or channel (to keep)

B = Switch or channel to add or remove

Select channel that operates motor on existing switch.
Press **P2**

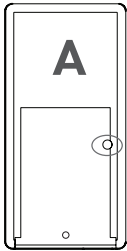

Motor response



Press **P2** a second time on existing switch.

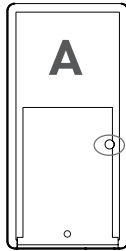

Motor response



Select desired channel on new switch. Press **P2** on new switch.

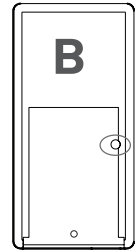

Motor response



5 INITIAL SET UP

5.1 Check motor direction

To check travel direction of shade, press **UP** or **DOWN** on controller..



Quick Press = Step

Long Press = Continuous Travel



IMPORTANT

Damage to shade may occur when operating motor prior to setting limits. Attention should be given.

To reverse shade direction, hold both **UP** and **DOWN**.

Until the motor responds.

Motor Response



IMPORTANT

Reversing motor direction using this method is only possible during initial set-up

Direction change will not occur if switch is locked.
See Section 6.3.

5.2 Set Limits

Move shade to the desired highest or lowest position by pressing the **UP** or **DOWN** buttons on controller.



To save upper limit, hold **UP** and **STOP**.

To save lower limit, hold **DOWN** and **STOP**.



IMPORTANT

Cycle shade up and down prior to setting limits to settle fabric



Initial set-up is not complete

Motor Response



IMPORTANT

After setting limits, motor will automatically exit from initial set-up mode.



IMPORTANT

For FT Motors, the bottom limit should be set - 1.38 in. (35mm) below the Ultra-Lock to disengage the auto lock mechanism when the shade is raised.

5.3 Locking the limit setting function

Stops unwanted changes to limit settings

Press **STOP** and hold for 15 seconds

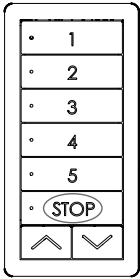

Release **STOP** button.
Locked limit settings

Press **STOP** and hold for 15 seconds

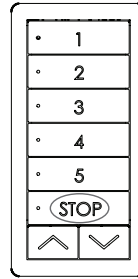

Release **STOP** button.
Unlocked limit settings

Remote Response



All lights flash x 1

Remote Response



All lights flash x 2

IMPORTANT

The locked setting will prevent any multi-button functions. These include reversing direction before setting limits, limit setting and toggling between tilt and roller modes.

6 ADJUSTING LIMITS

6.1 Adjust upper limit

Hold **UP** and **STOP** on controller.

Move shade to the desired highest position by pressing the **UP** button.

To save upper limit, hold **UP** and **STOP**.



Motor Response



Motor Response



6.2 Adjust lower limit

Hold **DOWN** and **STOP** on controller.

Move shade to the desired lowest position by pressing the **DOWN** button.

To save lower limit, hold **DOWN** and **STOP**.



Motor Response



Motor Response



IMPORTANT

For FT Motors, the bottom limit should be set ~ 1.38 in. [35mm] below the Ultra-Lock to disengage the auto lock mechanism when the shade is raised.

7 FAVORITE POSITIONING

7.1 Set a favorite position

Move shade to the desired position by pressing the **UP** or **DOWN** button on the controller.



Press **P2** on controller.

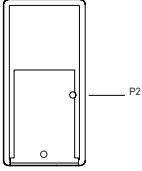

Press **STOP** on controller.

STOP

Press **STOP** on controller.

STOP

Motor Response



Motor Response



Motor Response



7.2 Send shade to favorite position

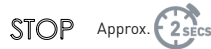

7.3 Delete favorite position

Press **P2** on controller.

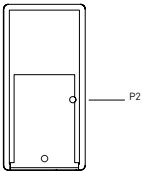

Press **STOP** on controller.

STOP

Press **STOP** on controller.

STOP

Motor Response



Motor Response



Motor Response



8 TROUBLE SHOOTING

Problem	Cause	Remedy
	Switch battery is discharged	Replace battery
Motor is not responding	Battery is inserted incorrectly	Check battery polarity
	Radio interference / Shielding	Ensure remote is positioned away from metal objects and that aerial on motor or receiver is kept straight and away from metal.
	Receiver distance is too far from remote	Move remote to a closer position or consider a repeater for improved performance.
	Power failure	Check power supply to motor is connected and active.
	Incorrect motor wiring	Check wiring is connected correctly (refer to motor installation instructions).
Cannot set limits on a single motor (multiple motors respond)	Using channel 0 to adjust motor limits (Multi channel remote ONLY)	Always reserve an individual channel for programming functions.
		SYSTEM BEST PRACTICE - Provide an extra 15 channel remote in your multi motor projects, that provides individual control for each motor for programming purposes.
Motor will not go down after setting the top limit.	Top limit was set using the DOWN and STOP buttons.	Reset the motor and begin programming sequence again. Remember that upper limit is to be set using the UP and STOP buttons, and the down limit is set using the DOWN and STOP buttons.
Motor will pair, but can not set limits.	Switch is in a locked state. Control must be unlocked to set limits or perform any multi-button functions.	Press and hold STOP button for 15 seconds, until locked state changes.

ROLLEASE ACMEDA
USA

750 East Main Street, 7th Floor
Stamford, CT 06902

T +1 203 964 1573 | F +1 203 358 5865

ROLLEASE ACMEDA
AUSTRALIA

110 Northcorp Boulevard,
Broadmeadows VIC 3047

T +61 3 9355 0100 | F +61 3 9355 0110

Queensland Branch
Unit 2/62 Borthwick Avenue,
Murarrie QLD 4172

ROLLEASE ACMEDA
EUROPE

Via Conca Del Naviglio 18, Milan
(Lombardia) Italy

T +39 02 8982 7317 | F +39 02 8982 7317

info@rolleasacmeda.com
rolleasacmeda.com