

R-Series 1.1Nm | 25mm

The motorized 25mm 1.1Nm R-Series roller shade system offers two motors for multiple tube diameters to suit a variety of applications. Featuring ARC (Automate Radio Communication), the motorized 25mm 1.1Nm R-Series system provides an intelligent, Li-ion battery powered solution.

AESTHETICAL FEATURES

- Thinner Motor Head
- Motor cap to color match with brackets

PRODUCTION & ASSEMBLY FEATURES

- Crown, drive and adapters available to suit multiple tube sizes
- Smaller Motor end deduction

FUNCTIONAL BENEFITS

- 5V Micro USB Charging
- Antennae Wire Retention Feature
- Levelling control
- Simple limit setting and adjustment
- Favorite position
- 3 operational speed settings
- ARC protocol for simple programming
- 2-WAY RF communication

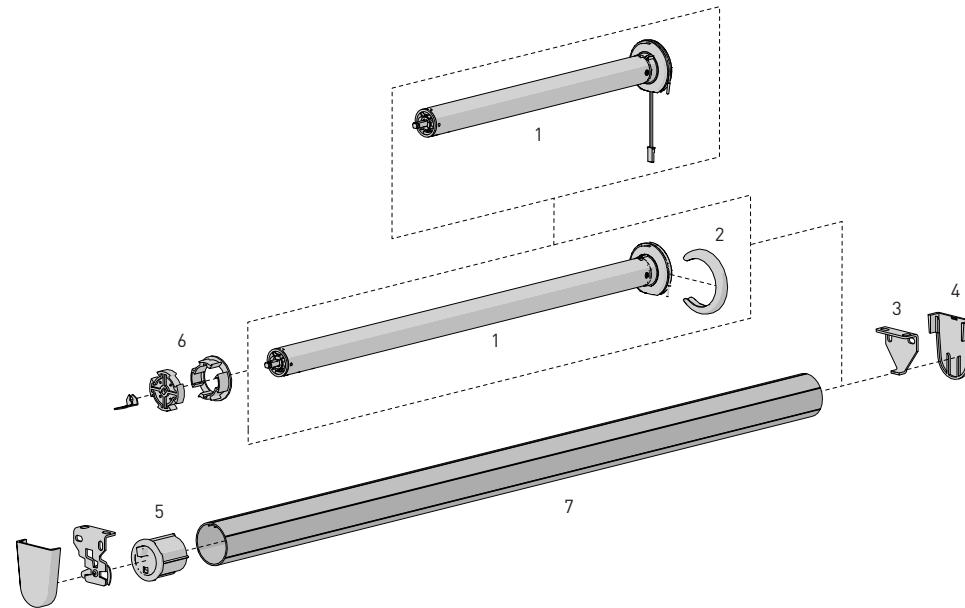

SYSTEM INDEX

1	Automate Motor 25mm MT01-1225-069002 - DCRF 1.1Nm 40rpm 12V ZERO MT01-1325-069001 - Li-ion 1.1Nm 20rpm 5V ZERO S. MT01-1325-069002 - Li-ion 1.1Nm 20rpm 5V ZERO MT01-1325-069012 - Li-ion 1.1Nm 20rpm 5V ZERO CT20 S. MT01-1325-069013 - Li-ion 1.1Nm 20rpm 5V ZERO CT20 MT01-1325-069015 - Li-ion 1.1Nm 28rpm 5V ZERO CT20
2	Motor Cap MT03-0502-027001 - Chrome MT03-0502-034001 - Satin Nickel MT03-0502-043001 - Brass MT03-0502-059001 - Black MT03-0502-077001 - White MT03-0502-079001 - Antique Bronze MT03-0502-091001 - Gun Metal
3	Brackets RB360xx - R8 1½" Set RB380xx - R8 2" Set RB390xx - R8 2-¾" Set
4	Bracket Covers RBPC360xx RBPC380xx
5	Pin End REP03xx - for 1¼" tube REP53xx - for 1½" tube
6	Crown and Drive Kit MT03-0109-069003 - Kit for 1¼" tube MTCRDR-25-1.5 - Kit for 1½" tube
7	Aluminum Tube RTEA3T## - 1¼" tube RTEA4T## - 1½" tube

- Size
xxx= Color

COLOR RANGE

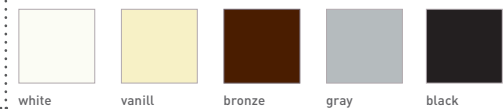

CONTROL OPTIONS

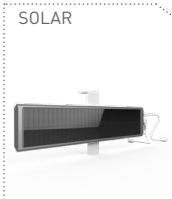

CHARGERS

OPTIONS

SYSTEM UPGRADES

SPECIFICATIONS

DEDUCTION CHART

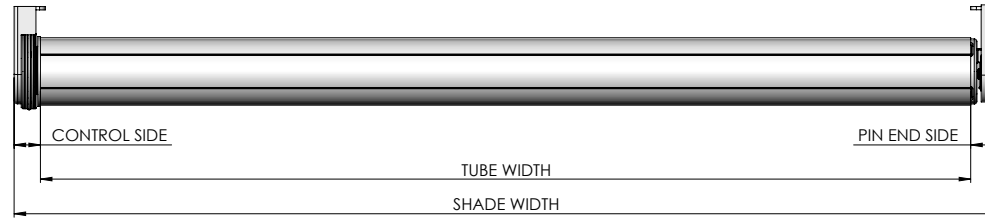

MINIMUM SHADE WIDTH		
TUBE	MOTOR	LENGTH
1 1/4"	MT01-1225-069002	14-5/16" [364mm]
	MT01-1325-069001	21-9/16" [548mm]
	MT01-1325-069002	24-7/16" [620mm]
1 1/2"	MT01-1225-069002	14-3/4" [374mm]
	MT01-1325-069001	21-15/16" [557mm]
	MT01-1325-069002	24-13/16" [630mm]

MOTOR	TUBE	BRACKETS	LIGHT GAP		
			CONTROL END	PIN END	OVERALL
ALL	1 1/4"	With Covers	9/16" [15mm]	11/16" [18mm]	1-5/16" [33mm]
		No Covers	1/2" [13mm]	5/8" [16mm]	1-1/8" [29mm]
ALL	1 1/2"	With Covers	9/16" [15mm]	11/16" [17mm]	1-1/4" [32mm]
		No Covers	1/2" [13mm]	9/16" [15mm]	1-1/8" [28mm]

MAX ROLL

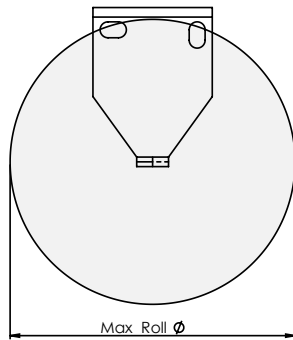

BRACKET	MAX ROLL SIZE
RB360xx	2.57" [69mm]
RB380xx	3.65" [92mm]
RB390xx	4.00" [101mm]

TUBE SPECS.

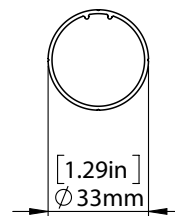

1 1/4" Tube
Code: RTEA3T12 (with tape)
Length 12', 16' (3.66m, 4.88m)

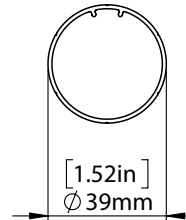

1 1/2" Tube
Code: RTEA4T12 (with tape)
RTEA4U12
RTEA4T16 (with tape)
RTEA4U16
Length 12', 16' (3.66m, 4.88m)

MOTOR	MAX LIFTING CAPACITY		MAX DROP*
	1-1/4" TUBE	1-1/2" TUBE	
1.1Nm	15.1lbs [6.8kg]	12.8lbs [5.8kg]	13.1' [4m]

* Recommended Max Drop. Exceeding this value may cause fabric tracking issues

SYSTEM CAPACITY

