

AUTOMATE®

Pulse PRO

Reliable, Long-Range Performance



Compatible with



Pulse PRO



The heart of your smart shades

Unlock the hidden potential of your home and experience the convenience of smarter shades with the Automate Pulse PRO hub.

Paired with the Automate Shades app installed on your smart device, the Pulse PRO centralizes control of your shades to the tip of your finger or the sound of your voice. When connected to the hub, your ARC shade motors can be automated or manually adjusted whenever you please – from home or away.

ARC

Automate Radio Communication

Powered by our proprietary communication technology, ARC enables an intuitive bi-directional signal, engineered to deliver a more reliable connection and better communication between your motor and control device.

Reliable and Secure Coverage

Pulse PRO offers complete, reliable control of your home's motorized shades with a powerful signal - ensuring consistent performance, even across larger spaces or complex floorplans.



A single Pulse PRO provides seamless control for up to 30 shades in a single-level, 3,000 sq. ft. home. For multi-level homes, adding a hub per extra floor ensures reliable connectivity by overcoming signal obstructions.

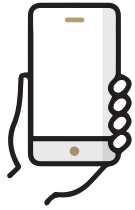

Pulse PRO Control Options

Automate Shades App



Simple and sophisticated smart phone control

Using the Automate Shades app, you are in complete control of your smart shades; personalise daily routines, organise and group your shades and automate your window coverings with Automate Scenes and Timers.

The Pulse PRO allows your shades to adapt to your day and move with your climate, schedule, and preference, completely autonomously.

Simply set your preferred daily routines and watch your shades do the rest. Automate shades can also shift with the movement of the sun, with the built-in sunrise/sunset feature, ensuring optimal, automatic sunlight and privacy control.

Sunrise / Sunset Automation

Automate shades adjust to the movement of the sun with a built-in sunrise/sunset feature, ensuring optimal, automatic sunlight and privacy control.



Simple 3-Step Installation

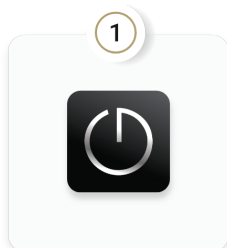

Open the Automate Shades App

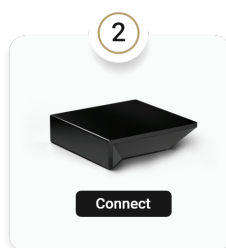

Connect the Pulse PRO



Pair your Shades

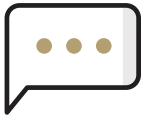

Pulse PRO Control Options

Voice Control

Shades that **listen**

When paired to the Automate Pulse PRO, your voice is all you need to control your Automate shades. Take advantage of Siri, Google Assistant or Alexa across any device, and operate your shades with naturally spoken voice commands.

Your smart assistants can understand you better than ever. “Close the shades a little” or “Raise the kitchen shades” is all that’s needed for your smart shades to move the way you want them to.

Control your shades individually or by groups, activate scenes, or simply set the shades to your desired height, all with the power of your voice.

Elevate your space with simultaneous group control.

Experience grouped shades rising and lowering together – true synchronised automation, ideal for open plan living areas.



Pulse PRO Control Options

Matter Compatibility

What is Matter?

Matter is a universal smart home standard that enables seamless, secure communication between devices from different brands.

Developed by Apple, Google, Amazon, and the Connectivity Standards Alliance (CSA), it works over Wi-Fi, Ethernet, and Thread, allowing smart devices—like lights, thermostats, and motorized shades—to connect reliably within one system.

Why does Matter matter?

Matter simplifies smart home automation by ensuring all devices work together effortlessly. With Matter-compatible products like the Pulse PRO, motorized shades integrate smoothly without extra hubs or complex setups. Whether using Wi-Fi for broad coverage or Thread for responsive control, Matter creates a reliable, future-proof smart home.



Ok Google, goodnight



Hey Siri, open kitchen shades



Alexa, turn on Good Morning scene



Pulse PRO Control Options

Smart Home Devices



Your smart devices working together

Achieve effortless control of your Automate smart window coverings and seamless integration with home automation systems for a feature-rich smart home solution. Easily control your Automate smarter shades in conjunction with your home's other smart devices including; lights, security, thermostats and home entertainment.

With SmartThings compatibility, the Pulse PRO enables all of your smart home devices to operate seamlessly under a single system.

Enjoy effortless smart home control for your shades, and your connected smart devices, all in one place.



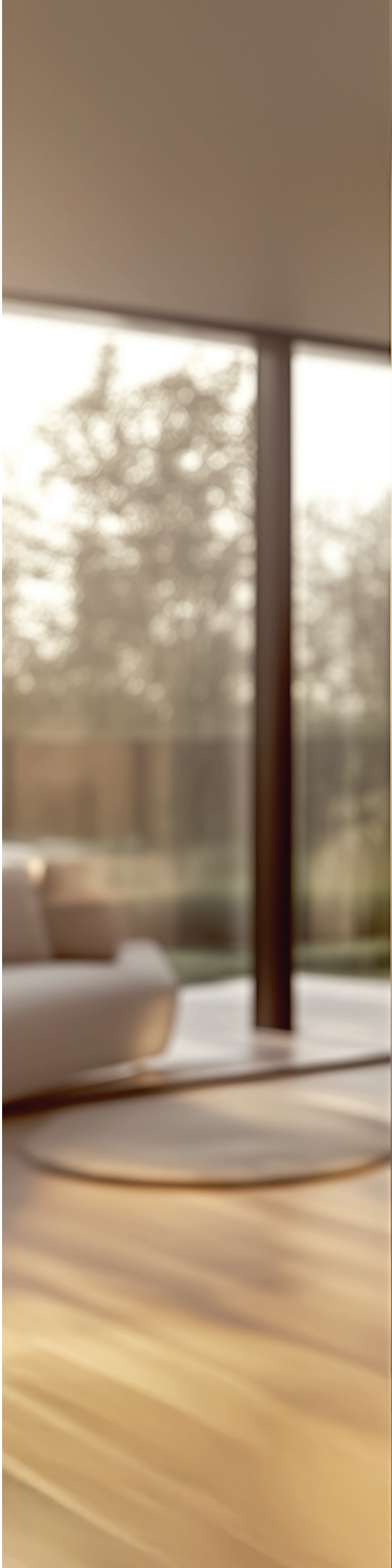

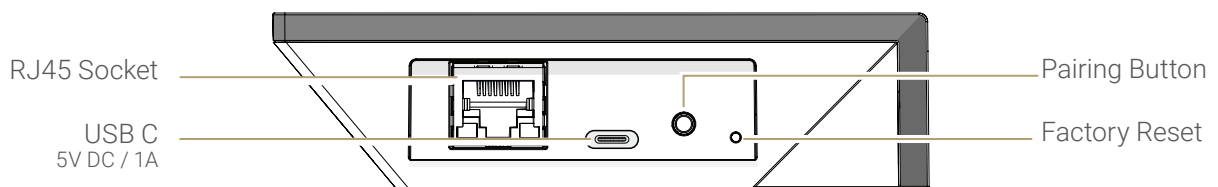
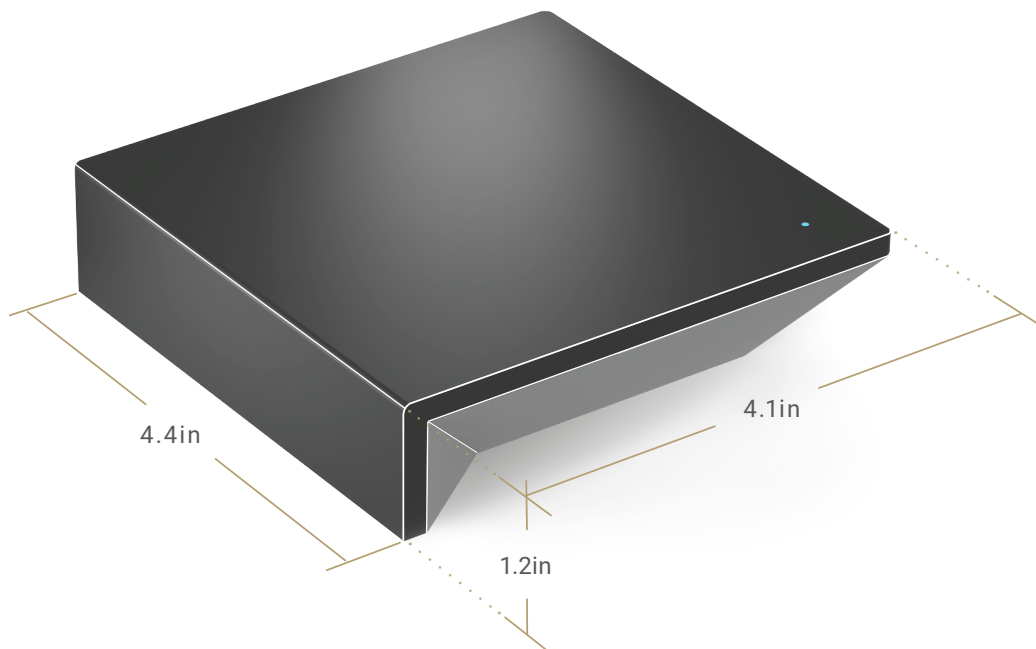

Pulse PRO



Your Support Program

 Phone Support
+1 800 552 5100

 Tech Support Email
ustechsupport@rolleaseacmeda.com

 Online Programming Assistant

 Knowledge Base Items

 YouTube Videos
[@RolleaseAcmeda](https://www.youtube.com/@RolleaseAcmeda)

 Full Document Listing

Technical Specifications

Input Voltage	5V
Input Power	1000mA
Shade Control Frequency	433.92 MHz - Bidirectional
Range	3,000 sq ft
Protection Class	IP20
Operation Temperature	32°F to 140°F (0°C to 60°C)
Connection	Ethernet and Wifi Bluetooth (Commissioning)
USB Cable Length	31 Inches / 80cm
Ethernet Cable	39 Inches / 100cm
Apple iOS Version	Needs to be 12.4 or greater
Android Version	Needs to be 7+ for app usage or 11+ for pairing
Devices	Compatible with Smart Phones and Tablets
Max no. of Hubs & Locations	5 hubs per Location, 5 Locations per Account
Devices per Hub	30
Rooms per Hub	30
Scenes per Hub	20
Timers per Hub	20
Automate Shades App Details & Device Compatibility	iOS (Needs to be 12.4 or greater) Android (Needs to be 7+ for app usage or 11+ for pairing) Phones Tablets
Third Party Device Integrations	Voice Control Platforms Apple HomeKit & Siri, Amazon Alexa, Google Assistant Home Automate Systems AMX, Control4, Crestron, ELAN, HomeSeer, RTI, Savant, Crestron Home / Clare Controls Smart Home Platforms Matter & SmartThings
Functions / Controls	Simultaneous Group Control Sunrise & Sunset Detection Capture Device Position to Scene Shade Health Screen Swipe Up & Down Controls & Buttons
Hub Offline	No Internet or Wifi If your hub is disconnected from the Internet and the Wifi Router, all timers that are programmed will continue to operate. No Internet but local Wifi If your internet service goes down and the hub is still connected to the Wifi Router, the following functions will still operate – Timer Activation, Activate a Single Device, Operate a Scene, Operate a Room, Shade Position Feedback and Shade Battery
Supported Window Coverings	Rollers Romans Cellular Drapes Venetians Zipscreens
Linq Tool	automateshades.com/us/pulse-linq-tool

Visit us online at
automateshades.com
For more information
on the Pulse PRO.